

Article number: 20194B50B502BL

Description: E+G
T-angel clamps GN194-B50-B50-2-BL

Measures

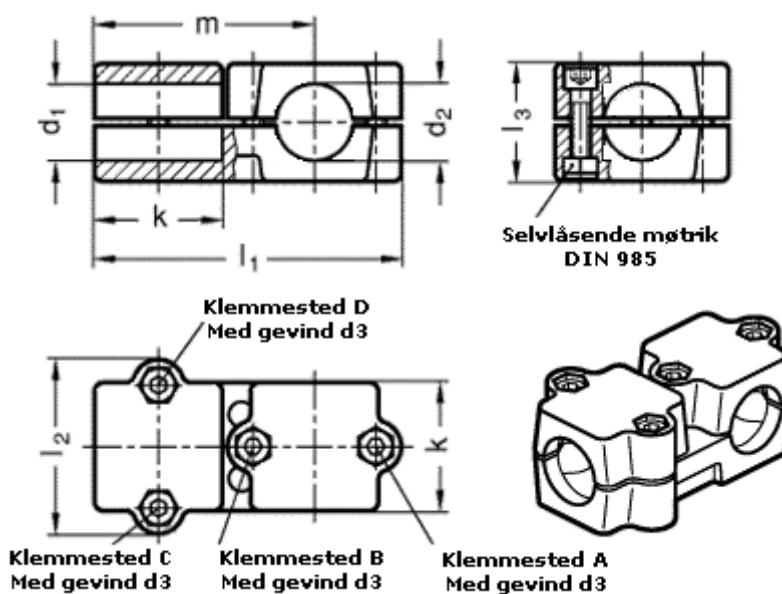

d1 = 50
d2 = 50
d3 = M10
k = 76
l1 = 176
l2 = 98
l3 = 70
m = 126